



De'Longhi Appliances
via Seitz, 47
31100 Treviso Italia

BEAN TO CUP ESPRESSO AND CAPPUCCINO MACHINE

Instruction for use



ESAM04.350

ELECTRICAL REQUIREMENTS

Before using this appliance ensure that the voltage indicated on the product corresponds with the main voltage in your home, if you are in any doubt about your supply contact your local electricity company.

The flexible mains lead is supplied connected to a B.S. 1363 fused plug having a fuse of 13 amp capacity.

Should this plug not fit the socket outlets in your home, it should be cut off and replaced with a suitable plug, following the procedure outlined below.

Note: Such a plug cannot be used for any other appliance and should therefore be properly disposed of and not left where children might find it and plug it into a supply socket - with the obvious consequent danger.

N.B. We recommend the use of good quality plugs and wall sockets that can be switched off when the machine is not in use.

IMPORTANT: the wires in the mains lead fitted to this appliance are coloured in accordance with the following code:

GREEN AND YELLOW
BLUE
BROWN

EARTH
NEUTRAL
LIVE

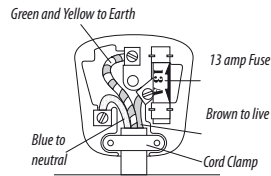

As the colours of the wires in the mains lead of this appliance may not correspond with the coloured markings identifying the terminals in your plug, proceed as follows:

- The wire which is coloured green and yellow must be connected to the terminal in the plug which is marked with the letter E or by the earth symbol \equiv or coloured green or green and yellow.
- The wire which is coloured blue must be connected to the terminal which is marked with the letter N or coloured black.
- The wire which is coloured brown must be connected to the terminal which is marked with the letter L or coloured red.

When wiring the plug, ensure that all strands of wire are securely retained in each terminal. Do not forget to tighten the mains lead clamp on the plug. If your electricity supply point has only two pin socket outlets, or if you are in doubt, consult a qualified electrician.

Should the mains lead ever require replacement, it is essential that this operation be carried out by a qualified electrician and should only be replaced with a flexible cord of the same size.

After replacement of a fuse in the plug, the fuse cover must be refitted. If the fuse cover is lost, the plug must not be used until a replacement cover is obtained. The colour of the correct replacement fuse cover is that of the coloured insert in the base of the fuse recess or elsewhere on the plug. Always state this colour when ordering a replacement fuse cover.

Only 13amp replacement fuses which are asta approved to B.S. 1362 should be fitted.

This appliance conforms to the Norms EN 55014 regarding the suppression of radio interference.

Warning - this appliance must be earthed

A

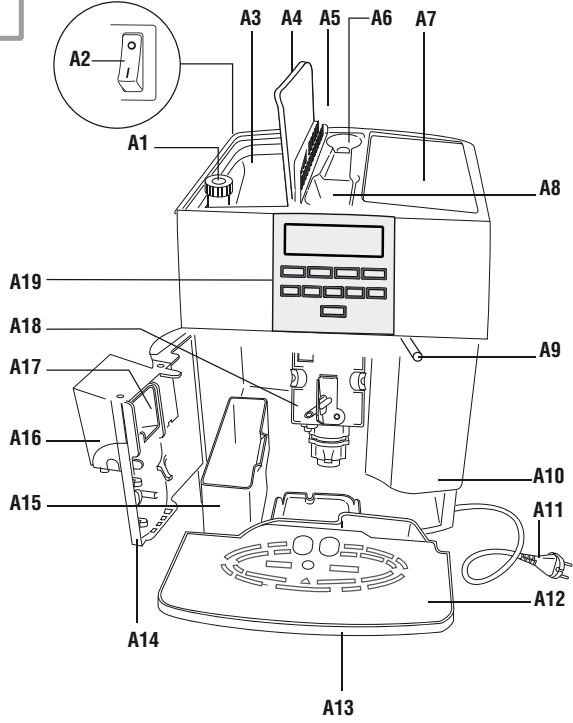

B

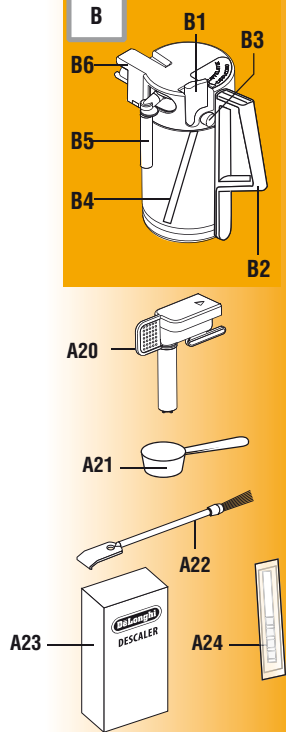

C

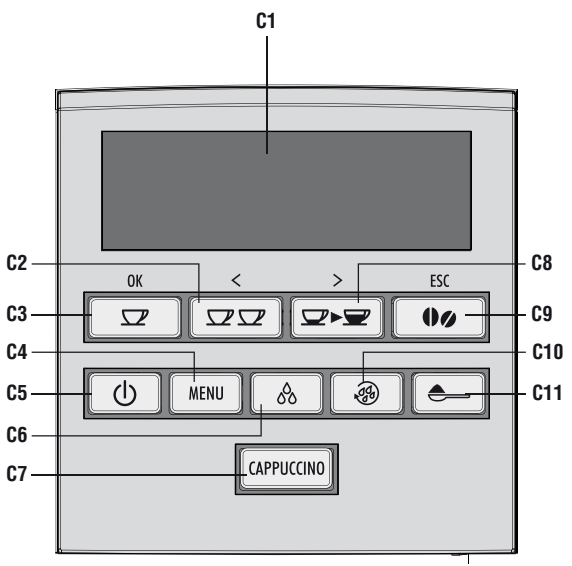

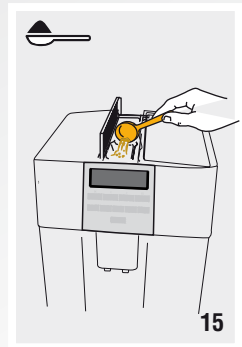
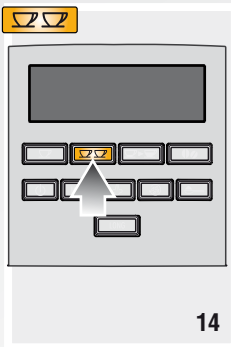
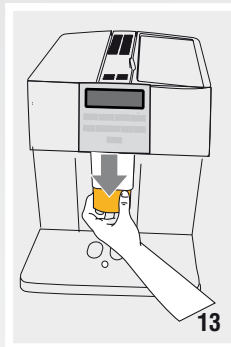
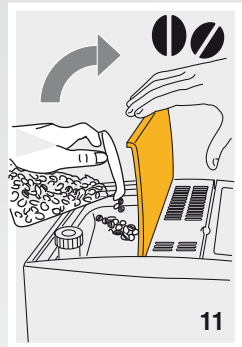
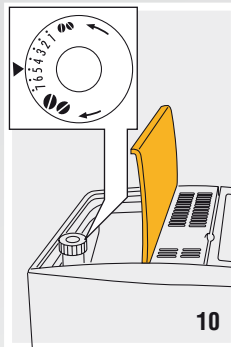
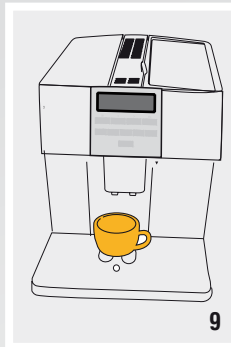
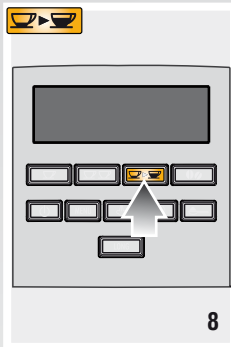
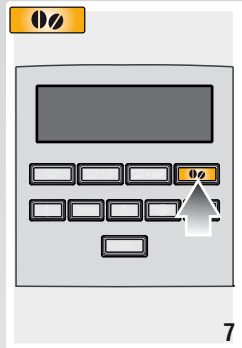
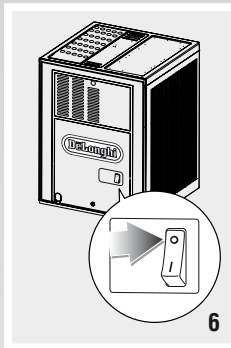
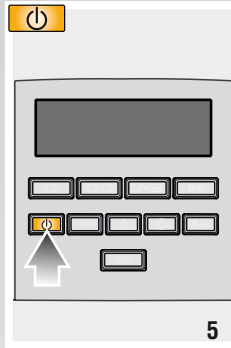
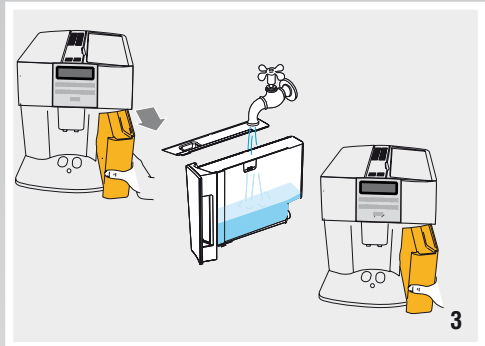
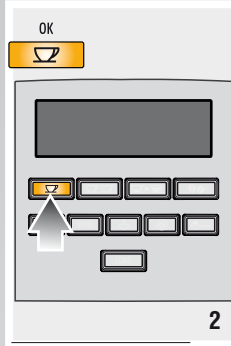
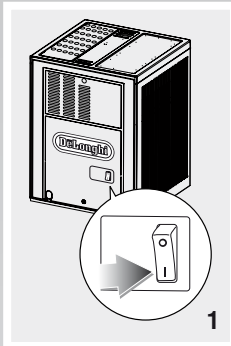

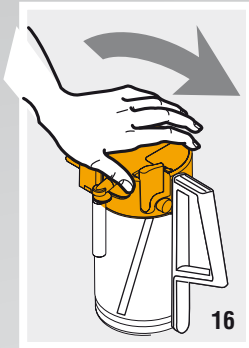

16



17

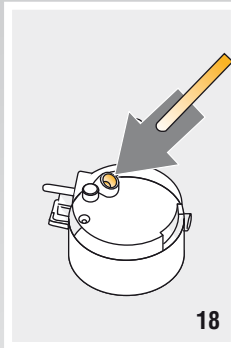

18



19

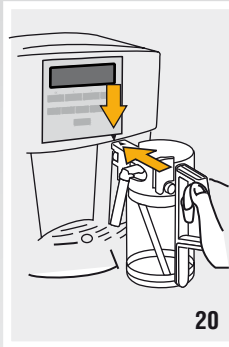

20



21

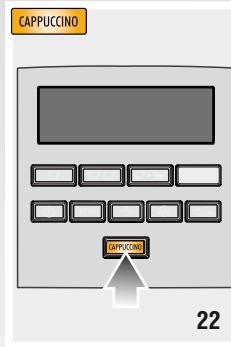

22



23

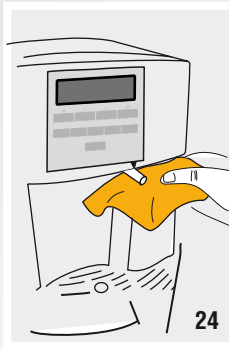

24

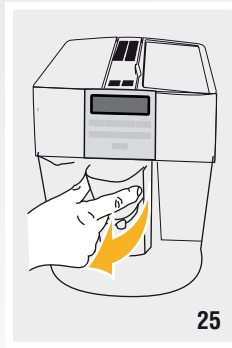

25

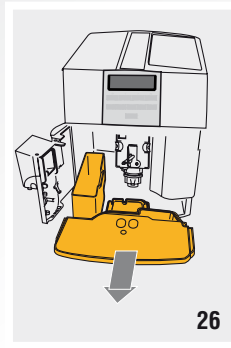

26

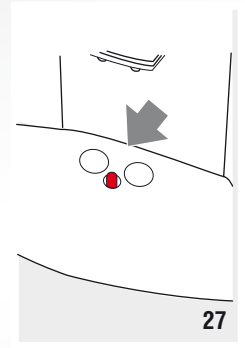

27

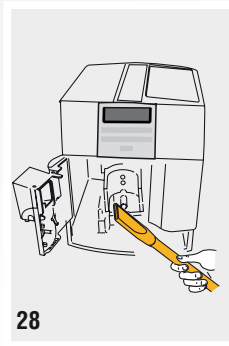

28

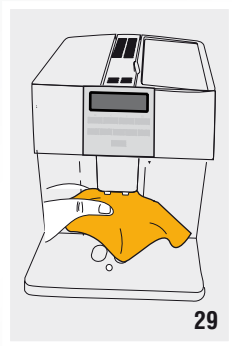

29

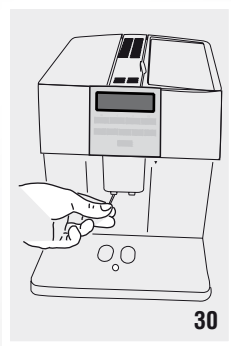

30



31

CONTENTS

ELECTRICAL REQUIREMENTS 2

INTRODUCTION 7

- Symbols used in these instructions 7
- Letters in brackets 7
- Troubleshooting and repairs 7

SAFETY 7

- Fundamental safety warnings 7

DESIGNATED USE 7

INSTRUCTIONS 8

DESCRIPTION 8

- Description of the appliance 8
- Description of the milk container 8
- Description of control panel 8

PRELIMINARY CHECKS 9

- Checking the appliance 9
- Installing the appliance 9
- Connecting the appliance 9
- Using the appliance for the first time 9

TURNING THE APPLIANCE ON 9

TURNING THE APPLIANCE OFF 10

MENU SETTINGS 10

- Descaling 10
- Setting the language 10
- Energy Saving 10
- Adjust time 10
- Auto-Start 10
- Auto-Off (Stand-by) 11
- Setting the temperature 11
- Statistics function 11
- Default values (reset) 11

MAKING COFFEE 11

- Selecting the coffee taste 11
- Selecting the quantity of coffee in the cup 11
- Customising the “my coffee” quantity 12
- Adjusting the coffee mill 12
- Tips for a hotter coffee 12
- Making coffee using coffee beans 12
- Making coffee using pre-ground coffee 12

MAKING DRINKS WITH MILK 13

- Filling and attaching the milk container 13
- Making Cappuccino of Latte Macchiato 13
- Making frothed milk (without coffee) 13
- Preparing milk (unfrothed and without coffee) 13
- Cleaning the milk frother with the CLEAN button 14
- Programming the quantities of coffee and milk in the cup 14

HEATING WATER 14

- Preparation 14
- Change the quantity of water delivered automatically. 14

CLEANING 14

- Cleaning the coffee maker 14
- Cleaning the coffee grounds container 15
- Cleaning the drip tray 15
- Cleaning the inside of the machine 15
- Cleaning the water tank 15
- Cleaning the coffee spouts 15
- Cleaning the pre-ground coffee funnel 15
- Cleaning the infuser 15
- Cleaning the milk container 16
- Cleaning the hot water/steam nozzle 16

DESCALING 16

SETTING WATER HARDNESS 17

- Measuring water hardness 17
- Set water hardness 17
- The machine is now reprogrammed with the new water hardness setting. 17

TECHNICAL SPECIFICATION 17

DISPOSAL 17

DISPLAYED MESSAGES 18

TROUBLESHOOTING 19

INTRODUCTION

Thank you for choosing the ESAM04.350 automatic coffee and cappuccino maker. We hope you enjoy using your new appliance. Take a few minutes to read these instructions. This will avoid all risks and damage to the machine.

Symbols used in these instructions

Important warnings are identified by these symbols. These warnings must absolutely be respected.



Failure to observe the warning could result in possibly life threatening injury from electric shock.



Failure to observe the warning could result in injury or damage to the appliance.



Failure to observe the warning could result in scalds or burns.



This symbol identifies important advice or information for the user.

Letters in brackets

The letters in brackets refer to the legend in the Description of the appliance on page 3.

Troubleshooting and repairs

In the event of problems, first try and resolve them following the information given in the sections “Displayed messages” on page 18 and “Troubleshooting” on page 19.

If this does not resolve the problem or you require further information, you should consult Customer Services by calling the number given on the annexed “Customer Service” sheet.

If your country is not among those listed on the sheet, call the number given in the guarantee.

If repairs are required, contact De’Longhi Customer Services only.

The addresses are given in the guarantee certificate provided with the machine.

SAFETY

Fundamental safety warnings



This is an electrical appliance and may cause electric shock.

You should therefore respect the following safety warnings:

- Never touch the appliance with damp hands or feet.
- Never touch the plug with damp hands.
- Make sure the socket used is freely accessible at all times, enabling the appliance to be unplugged when necessary.
- Unplug directly from the plug only. Never pull the power cable as you could damage it.
- To disconnect the appliance completely, place the main switch at the back of the appliance in the 0 position (fig. 6).
- If the appliance is faulty, do not attempt to repair. Turn it off, unplug from the mains socket and contact Customer Services.
- If the plug or power cable is damaged, it must be replaced by De’Longhi Customer Services only to avoid all risk.



- Keep all packaging (plastic bags, polystyrene foam) away from children.
- The appliance is not intended for use by persons (including children) with reduced physical, sensory or mental capabilities, or lack of experience and knowledge, unless they have been given supervision or instruction concerning use of the appliance by a person responsible for their safety. Children must be supervised to ensure they do not play with the appliance.



This appliance produces hot water and steam may form while it is in operation.

Avoid contact with splashes of water or hot steam.

DESIGNATED USE

This appliance is designed and made to prepare coffee and heat drinks.

All other use is considered improper.

This appliance is not suitable for commercial use.

The manufacturer is not liable for damage deriving from improper use of the appliance.

This is a household appliance only.

It is not intended for use in:

- staff kitchen areas in shops, offices and other working environments;
- farm houses;

- by clients in hotels, motels and other residential type environments;
- bed and breakfast type environments.

INSTRUCTIONS

Read these instructions carefully before using the appliance.

- Failure to respect these instructions may result in burns or damage to the appliance.
The manufacturer is not liable for damage deriving from failure to respect these instructions.



Please note:

Keep these instructions.

If the appliance is passed to other persons, they must also be provided with these instructions.

DESCRIPTION

Description of the appliance

(page 3 - **A**)

- A1. Grinding adjustment knob
- A2. Main switch
- A3. Beans container
- A4. Beans container lid
- A5. Cover for funnel and measure compartment
- A6. Measure compartment
- A7. Cup shelf (cup warmer active, when Energy Saving is disabled)
- A8. Pre-ground coffee funnel
- A9. Hot water and steam nozzle
- A10. Water tank
- A11. Power cable
- A12. Cup tray
- A13. Drip tray
- A14. Service door
- A15. Grounds tray
- A16. Coffee spout (adjustable height)
- A17. Coffee guide
- A18. Infuser
- A19. Control panel
- A20. Hot water spout
- A21. Measure
- A22. Cleaning brush
- A23. Descaler
- A24. Reactive strip to detect water hardness (Total hardness test)

Description of the milk container



(page 3 - **B**)







- B1. Lid with milk frother
- B2. Container handle
- B3. CLEAN button
- B4. Milk intake tube
- B5. Frothed milk spout
- B6. Milk container

Description of control panel

(page 3 - **C**)

A number of buttons on the panel have a dual function. This is indicated in brackets in the description.

- C1. Display: guides the user in using the appliance.
- C2.  button: to deliver two cups of coffee (*when you access the MENU: to scroll backwards through the menu*)
- C3.  button: to make 1 cup of coffee (*when you access the MENU: OK button to enable and confirm the selected function*)

- C4. **MENU** button: to access the settings menu.
- C5.  button: to turn the appliance on and off (stand-by)
- C6.  button to deliver hot water.
- C7. **CAPPUCCINO** button to deliver a cappuccino or frothed milk (press button twice)
- C8.  button: to select coffee quantity (*when you access the MENU: to scroll forwards through the menu*)
- C9.  button: to select coffee taste (*When you access the MENU: ESC to exit the menu*)
- C10.  button: to perform a rinse cycle
- C11.  button: to select pre-ground coffee

PRELIMINARY CHECKS

Checking the appliance

After removing the packaging, make sure the product is complete and undamaged and that all accessories are present. Do not use the appliance if it is visibly damaged. Contact De'Longhi Customer Services.

Installing the appliance



When you install the appliance, you should respect the following safety warnings:

- The appliance gives off heat. After positioning the appliance on the worktop, leave a space of at least 3 cm between the surfaces of the appliance and the side and rear walls and at least 15 cm above the coffee maker.
- Water penetrating the appliance could cause damage. Do not place the appliance near taps or sinks.
- The appliance could be damaged if the water it contains freezes. Do not install the appliance in a room where the temperature could drop below freezing point.
- Arrange the power cable in such a way that it cannot be damaged by sharp edges or contact with hot surfaces (e.g. electric hot plates).

Connecting the appliance



Check that the mains power supply voltage corresponds to the value indicated on the rating plate on the bottom of the appliance.

Connect the appliance to an efficiently earthed and correctly installed socket with a minimum current rating of 10A only. If the power socket does not match the plug on the appliance, have the socket replaced with a suitable type by a qualified professional.

Using the appliance for the first time



- Coffee has been used to factory test the appliance and it is therefore completely normal for there to be traces of coffee in the grinder. The machine is, however, guaranteed to be new.
- You should customise water hardness as soon as possible following the instructions in the section "Setting water hardness" on page 17.

1. Plug the appliance into the mains socket and place the main switch on the back of the appliance in the I position (fig. 1).

You must first choose the language (the languages scroll through at intervals of about 3 seconds).

2. When "English" appears, press the **OK** button (fig. 2). Once the language has been saved, the message "ENGLISH set" is displayed.

Follow the instructions indicated by the appliance:

3. "FILL TANK": remove the water tank, fill to the MAX line with fresh water then replace in the appliance (fig. 3).
4. "INSERT WATER SPOUT": Check that the hot water spout is inserted on the nozzle and place a container holding a minimum of 100 ml underneath (fig. 4).
5. "Hot water Press OK": press the OK button (fig. 2). "Please wait" is displayed and the appliance begins to deliver water from the hot water spout.

The appliance ends the first start up procedure, then the message "Turning off Please wait" is displayed and the appliance goes off.

The coffee maker is now ready for normal use.



- When using the appliance for the first time, you need to make 4-5 cups of coffee or 4-5 cappuccinos before the appliance starts to give satisfactory results.

TURNING THE APPLIANCE ON



Before turning the appliance on, make sure the main switch on the back of the appliance is in the I position (fig. 1).

Each time the appliance is turned on, it performs an automatic preheat and rinse cycle which cannot be interrupted.

The appliance is ready for use only after completion of this cycle.



During rinsing, a little hot water comes out of the coffee spouts and is collected in the drip tray underneath. Avoid contact with splashes of water.

- To turn the appliance on, press the  button (fig. 5). The message “Heating up Please wait” is displayed. After heating, the message “Rinsing” is displayed, together with a progress bar which gradually fills as preparation progresses. As well as heating the boiler, the appliance also heats the internal circuits by circulating hot water. The appliance is at temperature when the message indicating the taste and quantity of coffee appears.

TURNING THE APPLIANCE OFF

Each time the appliance is turned off, it performs an automatic rinse cycle which cannot be interrupted.



To avoid damaging the appliance, always press the  button to turn off.



During rinsing, a little hot water flows from the coffee spouts (only if coffee has been made).

Avoid contact with splashes of water.

To turn the appliance off, press the button  (fig. 5). The appliance performs a rinse cycle then goes off.



If the appliance is not used for an extended period, place the main switch in the 0 position (fig. 6).

Never place the main switch in the 0 position while the appliance is on.

No rinse is performed if no drinks with coffee have been made while the machine has been on.

MENU SETTINGS

When you access the settings menu by pressing the **MENU** button, the following menu items can be selected: Descaling, Set language, Energy saving, Adjust time, Auto-start, Auto-off, Set temperature, Water hardness, Statistics, Default values.

Descaling

For instructions on descaling, see page 16.

Setting the language

To modify the language of the display, proceed as follows:

1. Press the **MENU** button to enter the settings menu.
2. Press the **<or>** button until “Set language” is displayed;
3. Press the **OK** button;

4. Press the **<or>** button until the required language is displayed;
5. Press the **OK** button to confirm;
6. Press the **ESC** button exit the menu.

Energy Saving

Use this function to enable or disable “Energy saving” mode. When enabled, the function reduces energy consumption in compliance with European regulations.

To enable or disable the function, proceed as follows:

1. Press the **MENU** button to enter the settings menu.
2. Press the **<or>** button until “Energy saving” is displayed;
3. Press the **OK** button. “Disable?” is displayed (or “Enable?” if the function has already been disabled).
4. Press the **OK** button to disable or enable the function or the **ESC** button to exit the menu.

When the function is active, if the machine is not used for about 1 minute, “Energy saving” is displayed.



- To exit “Energy saving” mode, press any button, then press the button corresponding to the drink you want to make.
- A few seconds may elapse between “Energy saving” mode and delivery of the first drink; “Preparation underway...” is displayed.

Adjust time

To adjust the time on the display, proceed as follows:

1. Press the **MENU** button to enter the settings menu.
2. Press the **<or>** button until “Adjust time” is displayed;
3. Press the **OK** button. The hours flash on the display;
4. Press the **<or>** button to change the hours;
5. Press the **OK** button to confirm. The minutes flash on the display;
6. Press the **<or>** button to change the minutes;
7. Press the **OK** button to confirm;
8. Press the **ESC** button to exit the settings menu.



The time is displayed when the appliance is in stand-by or energy saving mode. If the time has not been adjusted, “0:00” flashes on the display.



Auto-Start

You can set the auto-start time in order to have the appliance ready at a certain time (for example in the morning) so you can make coffee immediately.



To enable this function, **the time must be set correctly.**

To enable Auto-on, proceed as follows:

1. Press the **MENU** button to enter the settings menu.
2. Press the **<or>** button until "Auto-start" is displayed;
3. Press the **OK** button. "Enable?" is displayed;
4. Press the **OK** button. The hours flash on the display;
5. Press the **<or>** button to select the hours;
6. Press the **OK** button to confirm. The minutes flash on the display;
7. Press the **<or>** button to change the minutes;
8. Press the **OK** button to confirm. The  symbol appears under "Auto-start" on the display.
9. Press the **ESC** button to exit the menu. When the appliance is in stand-by, the  symbol appears next to the clock to indicate that auto-start has been programmed.

To disable the function:

1. Press the **MENU** button to enter the settings menu.
2. Press the **<or>** button until "Auto-start" is displayed;
3. Press the **OK** button. "Disable?" is displayed;
4. Press the **OK** button to confirm;
5. Press the **ESC** button to exit the menu. When the appliance is in stand-by, the  symbol is no longer displayed.

Auto-Off (Stand-by)

The appliance is set by default to go off if not used for two hours.

The time can be changed so that the appliance switches off after 15 or 30 minutes, or after 1, 2 or 3 hours.

To re-programme Auto-off, proceed as follows:

1. Press the **MENU** button to enter the settings menu.
2. Press the **<or>** button until "Auto-off" is displayed;
3. Press the **OK** button;
4. Press the **<or>** button until the required time (15 or 30 minutes, or 1, 2 or 3 hours) is displayed;
5. Press the **OK** button to confirm;
6. Press the **ESC** button exit the menu.

Auto-off is programmed.

Setting the temperature

To modify the temperature of the water used to make the coffee, proceed as follows:

1. Press the **MENU** button to enter the settings menu.
2. Press the **<or>** button until "Set temperature" is displayed;
3. Press the **OK** button;
4. Press the **<or>** button until the required temperature is displayed (● = low; ●●●● = high);
5. Press the **OK** button to confirm;
6. Press the **ESC** button exit the menu.

Setting water hardness

For instructions on setting water hardness, see page 17.

Statistics function

This displays statistics relating to the machine.

To display, proceed as follows:

1. Press the **MENU** button to enter the settings menu.
2. Press the **<or>** button until "Statistics" is displayed;
3. Press the **OK** button;
4. By pressing the **<or>** button, you can check:
 - how many coffees have been made;
 - how many cappuccinos have been made;
 - how many times the machine has been descaled;
 - the total number of litres of water delivered.
5. Press the **ESC** button twice to exit the menu.

Default values (reset)

This resets all menu settings and programmed quantities back to the default values (with the exception of the language which remains as set). To reset all settings, proceed as follows:

1. Press the **MENU** button to enter the menu;
2. Press the **<or>** button until "Default values" is displayed;
3. Press the **OK** button;
4. The message "Confirm?" is now displayed;
5. Press the **OK** button to confirm and exit.

MAKING COFFEE



Please note!

A few seconds may elapse between energy saving mode and delivery of the first coffee.

Selecting the coffee taste

The appliance is set by default to make coffee with a standard taste.

You can also choose one of these tastes:

Extra-mild taste

Mild taste

Standard taste

Strong taste

Extra-strong taste

To change the taste, press the  button (fig. 7) repeatedly until the required taste is displayed.

Selecting the quantity of coffee in the cup



The appliance is set by default to make a standard quantity of coffee.

To select the quantity of coffee, press the  button (fig. 8) repeatedly until the message corresponding to the required quantity of coffee is displayed:

Corresponding coffee	ESPRESSO (ml)
MY COFFEE	program. from ≈20 to ≈180
SHORT	≈40
STANDARD	≈60
LONG	≈90
EXTRA LONG	≈120

Customising the “my coffee” quantity

The appliance is set by default to automatically deliver 30 ml of “MY COFFEE”. To modify these settings, proceed as follows:

1. Place a cup under the coffee spouts (fig. 9).
2. Press the  (button repeatedly (fig. 8) until “MY COFFEE” is displayed.
3. Keep the  button (fig. 2) pressed until the message “Program Quantity” is displayed. Release the button. The machine starts making the coffee;
4. As soon as the coffee in the cup reaches the required level, press the  button again.

The quantity set has now been programmed.

Adjusting the coffee mill

The coffee mill is set by default to prepare coffee correctly and should not require regulating initially.

However, if after making the first few coffees you find that delivery is either too fast or too slow (a drop at a time), this can be corrected by adjusting the grinding adjustment knob (fig. 10).

Please note!

The grinding adjustment knob must only be turned when the coffee mill is in operation.

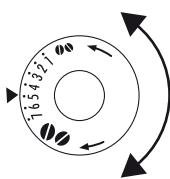

For faster delivery (not a drop at a time), turn one click clockwise towards “7” (coarser ground coffee).

For fuller bodied creamier coffee, turn one click anticlockwise towards “1” (finer ground coffee).

These adjustments will only be evident after at least 2 cups of coffee have been delivered. If delivery is still too fast or too slow, repeat the correction, turning the knob another click.

Tips for a hotter coffee

For a hotter coffee, you are recommended to:

- before delivering the coffee, perform a rinsing cycle by pressing the  button to select the “Rinsing” function.



Hot water is delivered from the spout, heating the internal circuits of the appliance and thus raising the coffee temperature.

- place the cups on the cup warmer until they are warm.
- warm the cups by rinsing them with hot water (using the hot water function).
- set the “high” coffee temperature (●●●●) in the menu.

Making coffee using coffee beans





Important!

Do not use caramelised or candied coffee beans as they could stick to the coffee mill and make it unusable.

1. Fill the container with coffee beans (fig. 11).
2. Place under the coffee spouts:
 - 1 cup, if you want to make 1 coffee (fig. 9);
 - 2 cups, if you want 2 coffees (fig. 12);
3. Lower the spouts as near as possible to the cup. This makes a creamier coffee (fig. 13).
4. Press the button corresponding to the number of coffees required (1 cup  or 2 cups ) (fig. 2 and 14).
5. Preparation begins. The quantity of coffee is displayed together with a progress bar which gradually fills as preparation progresses.

Once the coffee has been made, the appliance prepares for use again.

Please note:

- While the machine is making coffee, delivery can be interrupted at any moment by pressing one of the coffee buttons ( or ).
- At the end of delivery, to increase the quantity of coffee in the cup, just press (within 3 seconds) one of the coffee buttons ( or ).

Once the coffee has been made, the appliance is ready to use again.

Important!

If the coffee is delivered a drop at a time, too fast and not creamy enough or too cold, read the tips in the “Troubleshooting” section on page 19.

Various alarm messages could be displayed while using the machine. Their meaning is explained in the section “Displayed messages” (page 18).

Making coffee using pre-ground coffee

Important!

- Never add pre-ground coffee when the machine is off or it could spread through the inside of the machine and dirty



it. This could damage the appliance.



- Never use more than one level measure or it could dirty the inside of the machine or block the funnel.



i Please note!

If you use pre-ground coffee, you can only make one cup of coffee at a time.

1. Press the  (C11) button: “Pre-ground” flashes on the display.
2. Put one level measure of pre-ground coffee into the funnel (fig. 14).
3. Place a cup under the coffee spouts (fig. 9).
4. Press the  delivery button (fig. 2).
5. Preparation begins. A bar appears on the display and gradually fills as preparation progresses.

Once the coffee has been made, the appliance prepares for use again. To disable the pre-ground coffee function, press the  or  button again.

MAKING DRINKS WITH MILK

i Please note!

To avoid producing milk with poor froth or large bubbles, always clean the milk container lid and hot water nozzle as described in the section “Cleaning the milk container” and “Cleaning the hot water/steam nozzle” (page 16).

Filling and attaching the milk container

1. Remove the lid (fig. 16);
2. Fill the milk container with a sufficient quantity of milk, not exceeding the MAX level marked on the handle (fig. 17).

i Please note!

- For a denser more even froth, you must use skimmed or partially skimmed milk at refrigerator temperature (about 5°C).

The quality of froth can be adjusted during delivery by moving the regulator slightly towards the word CAFFELATTE for less froth.

Moving it towards the word CAPPUCCINO obtains a more froth.



- If “Energy Saving” mode is enabled, you may have to wait a few seconds before the first cappuccino is delivered.

During this time, “Preparation underway...” is displayed.

3. Make sure the milk intake tube is correctly inserted in the bottom of the milk container lid (fig. 18).
4. Place the lid back on the milk container.
5. Remove the hot water spout from the nozzle (fig. 19).
6. Attach the container to the nozzle, pushing as far as it will go (fig. 20).
7. Follow the instructions for each function.

Making Cappuccino of Latte Macchiato

1. Attach the milk container (see previous section) and place a sufficiently large cup under the coffee spouts and milk spout.
2. Place the frothed milk regulator between “CAPPUCCINO” and “CAFFELATTE” (fig. 21).
3. Press the **CAPPUCCINO** button (fig. 22). “CAPPUCCINO” is displayed, together with a progress bar which fills gradually as preparation proceeds.
4. After a few seconds, frothed milk flows out of the milk spout into the cup below. If the froth is not satisfactory, move the milk regulator towards “CAPPUCCINO” (= + froth) or towards “CAFFELATTE” (= - froth). Milk delivery stops automatically and coffee delivery begins.
5. The cappuccino is ready. Sweeten to taste and, if desired, sprinkle the froth with a little cocoa powder.

i Please note!

- If you want to interrupt preparation during delivery, press the CAPPUCCINO button.
- At the end of delivery, to increase the quantity of coffee in the cup, just press (within 3 seconds) the CAPPUCCINO button.
- Do not leave the milk container out of the refrigerator for longer than strictly necessary. The warmer the milk (5°C ideal), the poorer the froth will be.

Making frothed milk (without coffee)

To make frothed milk, proceed as described in the previous section, placing the milk froth regulator in the CAPPUCCINO position and pressing the **CAPPUCCINO** button twice consecutively (within two seconds) (fig. 22).

The appliance displays “Frothed milk”.

i Please note!

If during delivery you want to stop making milk or coffee, press the **CAPPUCCINO** button once.

Preparing milk (unfrothed and without coffee)

Proceed as described in the previous section, placing the milk froth regulator in the CAFFELATTE position.

Cleaning the milk frother with the CLEAN button



When cleaning the internal tubes of the milk container, a little hot water leaks out of the frothed milk tube (B5).

Avoid contact with splashes of water.

“Press CLEAN button” flashes on the display each time you use a milk function. To eliminate all milk residues, proceed as follows:

1. Leave the milk container in the machine (you do not need to empty it);
2. Place a cup or other recipient under the frothed milk spout.
3. Press the “CLEAN” button (fig. 23) and keep pressing until the progress bar which appears on the display together with the message “Cleaning underway” is complete;
4. Remove the milk container and always clean the nozzle with a sponge (fig. 24).



- When “Press CLEAN button” flashes on the display, you can still prepare any type of coffee or milk. If you have to make a number of drinks with milk, wait until you have delivered the last cup before cleaning the container.
- The milk left in the container can be kept in the refrigerator.
- In some cases, to clean you must wait for the appliance to heat up, holding the CLEAN button down.

Programming the quantities of coffee and milk in the cup

The appliance is set by default to automatically deliver standard quantities.

To change these quantities, proceed as follows:

1. Place a cup under the coffee spouts and milk spout.
2. Press the **CAPPUCCINO** button and hold down for at least 8 seconds until the message “Milk for CAPPUCCINO Program Quantity” is displayed.
3. Release the button. The appliance starts delivering milk.
4. Once the required quantity of milk has been delivered into the cup, press the **CAPPUCCINO** button again.
5. After a few seconds, the appliance starts delivering coffee into the cup and the message “Coffee f. CAPPUCCINO Program Quantity” is displayed.
6. Once the required quantity of coffee has been delivered into the cup, press the **CAPPUCCINO** button. Coffee delivery stops.

The machine is now reprogrammed with the new quantities.

HEATING WATER





A few seconds may elapse between “Energy saving” mode and delivery of hot water; “Preparation underway...” is displayed.

Preparation





Never leave the machine unsupervised while delivering hot water.

The hot water spout becomes hot while water is being delivered and must be handled by the handle only.

1. Make sure the hot water spout is attached correctly
2. Place a container under the water spout (as close as possible to avoid splashes) (fig. 4).
3. Press the  button. The message “Hot Water” is displayed.
4. Water flows out of the spout. Delivery stops automatically after about 250 ml.
5. To interrupt delivery of hot water manually, press the  button again.

Change the quantity of water delivered automatically.

The appliance is set by default to automatically deliver 250ml. To modify these quantities, proceed as follows:

1. Position a container under the spout.
2. Press the  button until the message “Hot Water Program Quantity” is displayed.
3. When the hot water in the cup reaches the required level, press the  button again.

The machine is now reprogrammed with the new quantity.

CLEANING



- Do not use solvents, abrasive detergents or alcohol to clean the appliance. With De’Longhi superautomatic coffee makers, you need not use chemical products to clean the machine.
- None of the components can be washed in a dishwasher apart from the milk container (B).
- Do not use metal objects to remove encrustations or coffee deposits as they could scratch metal or plastic surfaces.

Cleaning the coffee maker

The following parts of the machine must be cleaned regularly:

- coffee grounds container (A15),
- drip tray (A13),
- the inside of the machine, accessible after opening the service door (A14),

- water tank (A10),
- coffee spouts (A16) and hot water nozzle (A9),
- pre-ground coffee funnel (A7),
- infuser (A18)
- milk container (B).

Cleaning the coffee grounds container

When "EMPTY GROUNDS CONTAINER" is displayed, the grounds container must be emptied and cleaned.

Until the grounds container has been cleaned, the appliance continues to display the message and coffee cannot be made.

1. Open the service door on the front of the appliance (fig. 25), extract the drip tray (fig. 26), empty and clean.
2. Empty the grounds container and clean thoroughly to remove all residues left on the bottom. This can be done with the spatula or the brush provided.
3. Replace the drip tray complete with grounds container.
4. Close the service door.



When removing the drip tray, the grounds container **must** be emptied, even if it contains few grounds. If this is not done, when you make the next coffees, the grounds container may fill up more than expected and clog the machine.

Cleaning the drip tray



If the drip tray is not emptied regularly, the water could overflow from the edge and seep inside or around the machine. This could damage the machine, the surface it rests on or the surrounding area.

The drip tray is fitted with a level indicator (red) showing the level of water it contains (fig. 26).

Before the indicator protrudes from the cup tray, the drip tray must be emptied and cleaned.

To remove the drip tray:

1. Open the service door (fig. 25);
2. Remove the drip tray and the grounds container (fig. 26);
3. Empty the drip tray and grounds container and wash them;
4. Replace the drip tray complete with grounds container;
5. Close the service door.

Cleaning the inside of the machine



Before cleaning internal parts, the machine must be turned off (see "Turning off", page 10) and unplugged from the mains power supply.

Never immerse the coffee maker in water.

1. Check regularly (about every 100 coffees) that the inside of the appliance (accessible after removing the drip tray) is not dirty. If necessary, remove coffee deposits with the brush supplied.
2. Remove the residues with a vacuum cleaner (fig. 28).

Cleaning the water tank

1. Clean the water tank (A10) regularly (about once a month) with a damp cloth and a little mild washing up liquid.
2. Clean to remove all washing up liquid residues, then rinse the water tank thoroughly.
3. Fill the tank with fresh water and put back in the appliance.

Cleaning the coffee spouts

1. Clean the coffee spouts with a sponge or cloth (fig. 29).
2. Check the holes in the coffee spout are not blocked. If necessary, remove coffee deposits with a toothpick (fig. 30).

Cleaning the pre-ground coffee funnel

Check regularly (about once a month) that the pre-ground coffee funnel (A7) is not blocked. If necessary, remove coffee deposits with the brush (A22) supplied.

Cleaning the infuser

The infuser (A18) must be cleaned at least once a month.



The infuser may not be extracted when the machine is on.

1. Make sure the machine is correctly turned off (see "Turning off", page 10).
2. Open the service door (fig. 24).
3. Extract the drip tray and the grounds container (fig. 26).
4. Press the two red release buttons inwards and at the same time pull the infuser outwards (fig. 31).



RINSE WITH WATER ONLY

NO WASHING UP LIQUID - NO DISH WASHER

Do not use washing up liquid to clean the infuser as it could cause damage.

5. Soak the infuser in water for about 5 minutes, then rinse under the tap.
6. Use the brush (A22) to remove any coffee residues left in the infuser housing, visible through the infuser door.
7. After cleaning, replace the infuser by sliding it onto the internal support and pin at the bottom, then push the

PUSH symbol fully in until it clicks into place.

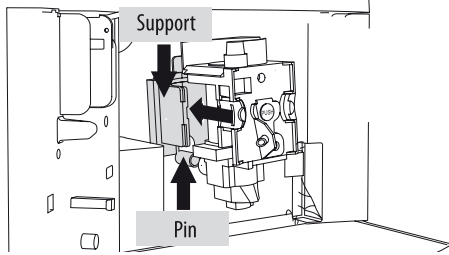

i Please note!

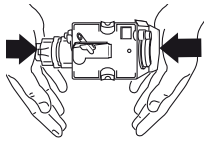

If the infuser is difficult to insert, you must first adapt it to the right dimensions by pressing it forcefully from the bottom and top as shown in the figure.

8. Once inserted, make sure the two red buttons have snapped out.
9. Replace the drip tray and waste coffee container.
10. Close the service door.

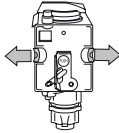

Cleaning the milk container

Clean the milk container each time you prepare milk as described below:

1. Remove the lid of the milk container.
2. Remove the milk spout and intake tube.
3. Wash all the components thoroughly with hot water and mild washing-up liquid.

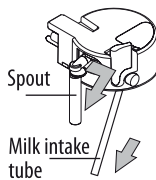

All components are dishwasher safe, placing them in the top basket of the dishwasher.

4. Make sure there are no milk residues left inside the holes.
5. Check that the intake tube and spout are not clogged with milk residues.
6. Replace the milk spout and intake tube.
7. Replace the milk container lid.

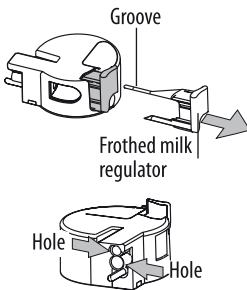

Cleaning the hot water/steam nozzle

Each time you prepare milk, clean the nozzle with a sponge to remove milk residues from the gaskets (fig. 24).

DESCALING

Descal the machine when the message "DESCALE" flashes on the display.

! Important!

Descaler contains acids which may irritate the skin and eyes. It is vital to respect the manufacturer's safety warnings given on the descaler pack and the warnings relating to the procedure to follow in the event of contact with the skin and eyes.

i Please note!

Use De'Longhi descaler only. Under no circumstances should you use sulphamic or acetic based descalers. Their use invalidates the guarantee.

Failure to descale the appliance as described above also invalidates the guarantee.

1. Turn the machine on.
2. Press the **MENU** button to enter the settings menu. Press the **<or>** button until "Descal" is displayed;
3. Press the **OK** button to confirm: The message "Add descaler Press OK" is displayed.
4. Before confirming empty the water tank (A10) completely. Pour the descaler (A23) diluted with water (respecting the proportions indicated on the descaler pack) into the water tank and replace the tank in the appliance.

! Important! Danger of burns

Hot water containing acid flows out of the hot water spout. Avoid contact with splashes of water.

5. Place an empty container with a minimum capacity of 1.5 litres under the hot water spout.
6. Confirm with the **OK** button.
7. After confirming by pressing OK, the message "Descal underway" is displayed. The descale programme starts and the descaler liquid comes out of the water spout. The descale programme automatically performs a series of rinses and pauses to remove limescale deposits from inside the machine.

After about 30 minutes, the message "Rinsing FILL TANK" is displayed.

8. The appliance is now ready for rinsing through with clean water. Remove the water tank, empty, rinse under running water, fill with clean water and replace. "Rinsing Press OK" is displayed.
9. Empty the container used to collect the descaler solution and replace it under the cappuccino maker.

10. Press the **OK** button to start rinsing. Hot water flows out of the spout and the message "Rinsing Please wait" is displayed.
 11. When the water tank is completely empty, the message "Rinsing complete Press OK" is displayed.
 12. Press the **OK** button. The appliance goes off automatically.
- To turn the appliance on again, press the  button.

SETTING WATER HARDNESS

The DESCAL message is displayed after a period of time established according to water hardness.

The machine is set by default for a hardness value of 4.

The machine can also be programmed according to the actual hardness of the mains water in the various regions, varying the frequency with which the message is displayed.

Measuring water hardness

1. Remove the "TOTAL HARDNESS TEST" (A24) indicator paper from its pack.
2. Immerse the paper completely in a glass of water for one second.
3. After about a minute, 1, 2, 3, or 4 red squares form, depending on the hardness of the water. Each square corresponds to one level.

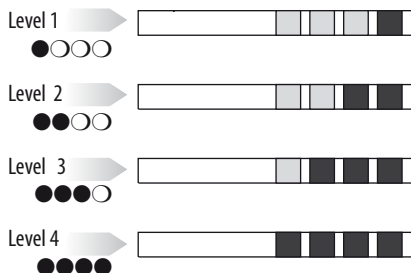

Set water hardness

1. Press the **MENU** button to enter the settings menu.
2. Press the **<or>** button and select "Water hardness".
3. Confirm the selection by pressing the **OK** button.
4. Press **<or>** to set the water hardness identified using the indicator paper (see figure in the previous section).
5. Press the **OK** button to confirm the setting.
6. Press the **ESC** button to exit the menu.

The machine is now reprogrammed with the new water hardness setting.

TECHNICAL SPECIFICATION

Voltage:	220-240 V~ 50/60 Hz max. 10A
Absorbed power:	1350W
Pressure:	15 bar
Water tank capacity:	1,8 L
Size: LxHxD:	282x364x425 mm
Cable length:	1,5 m
Weight:	11 Kg
Max. beans container capacity:	200 g

 The appliance complies with the following EC directives:

- Stand-by Directive no. 1275/2008
- Low Voltage Directive 2006/95/EC and subsequent amendments;
- EMC Directive 2004/108/EC and subsequent amendments
- Materials and accessories coming into contact with food conform to the provisions of EC regulation 1935/2004.

DISPOSAL



Important information for correct disposal of the product in accordance with EC Directive 2002/96/EC. At the end of its working life, the product must not be disposed of as urban waste.

It must be taken to a special local authority differentiated waste collection centre or to a dealer providing this service.

Disposing of a household appliance separately avoids possible negative consequences for the environment and health deriving from inappropriate disposal and enables the constituent materials to be recovered to obtain significant savings in energy and resources.

As a reminder of the need to dispose of household appliances separately, the product is marked with a rubbish bin bearing a cross.

DISPLAYED MESSAGES

DISPLAYED MESSAGE	POSSIBLE CAUSE	REMEDY
FILL TANK	Insufficient water in the tank.	Fill the tank with water and/or insert it correctly, pushing it as far as it will go until it clicks into place (fig. 3).
GROUND TOO FINE ADJUST MILL	The grinding is too fine and the coffee is delivered too slowly or not at all.	Repeat coffee delivery and turn the grinding adjustment knob one click clockwise towards "7" while the coffee mill is in operation. If after making at least 2 coffees delivery is still too slow, repeat the correction procedure, turning the Grinding adjustment knob another click until delivery is correct.
INSERT WATER SPOUT	The water spout is not inserted or is inserted incorrectly.	Insert water spout as far as it will go (fig. 4).
EMPTY GROUNDS CONTAINER	The grounds container is full.	Empty the grounds container and clean, then replace. Important: when removing the drip tray, the grounds container MUST be emptied, even if it contains few grounds. If this is not done, when you make the next coffees, the grounds container may fill up more than expected and clog the machine. (To ensure the 72 hours are calculated correctly, the appliance must never be turned off with the main switch in the 0 position.)
	72 hours have passed since the first coffee after the grounds container was last emptied.	
INSERT GROUNDS CONTAINER	After cleaning, the grounds container has not been replaced.	Open the service door, remove the drip tray and insert the grounds container.
ADD PRE-GROUND COFFEE	The "pre-ground coffee" function has been selected without placing any pre-ground coffee in the funnel.	Place pre-ground coffee in the funnel or deselect the "pre-ground" function.
DESCALE	The machine must be descaled.	The descaling procedure described in the "Descaling" section needs to be performed as soon as possible.
LESS COFFEE	Too much coffee has been used.	Select a milder taste or reduce the quantity of pre-ground coffee.
FILL BEANS CONTAINER	The coffee beans have run out.	Fill the beans container
	The pre-ground coffee funnel is clogged.	Empty the funnel as described in the section "Cleaning the pre-ground coffee funnel".
INSERT INFUSER ASSEMBLY	The infuser has not been replaced after cleaning.	Insert the infuser as described in the paragraph "Cleaning the infuser".
CLOSE DOOR	The service door is open	Close the service door.
INSERT MILK CONTAINER	The milk container is not inserted correctly.	Insert the milk container as far as it will go.
PRESS CLEAN	Milk has been delivered recently and the tubes inside the milk container must be cleaned.	Press the "CLEAN" button and keep pressing until the progress bar is complete. "Cleaning underway" is displayed.
Energy Saving	The function is active and reduces electricity consumption.	Disable the function from the menu (See section "Energy Saving").
GENERAL ALARM	The inside of the appliance is very dirty.	Clean the inside of the appliance thoroughly, as described in the section "Cleaning and maintenance". If the message is still displayed after cleaning, contact a service centre.
EMPTY CIRCUIT FILL CIRCUIT <i>alternating with...</i> Hot water Press OK	The water circuit is empty	Press OK button to deliver water from the spout until it flows out normally.

TROUBLESHOOTING

Below is a list of some of the possible malfunctions. If the problem cannot be resolved as described, contact Customer Services.

PROBLEM	POSSIBLE CAUSE	REMEDY
The coffee is not hot	The cups were not preheated.	Warm the cups by rinsing them with hot water (using the hot water function).
	The infuser has cooled down because 2/3 minutes have elapsed since the last coffee was made.	Before making the coffee, heat the infuser using the rinse  button.
	A low coffee temperature is set.	Set maximum coffee temperature in the menu (●●●●).
The coffee is not creamy enough.	The coffee is ground too coarsely.	Turn the grinding adjustment knob one click anticlockwise towards "1" while the coffee mill is in operation (fig. 8). Continue one click at a time until coffee delivery is satisfactory. The effect is only visible after delivering 2 coffees (see the section: "Adjusting the coffee mill" on page 12).
	Wrong type of coffee	Use a type of coffee for espresso coffee makers.
The coffee is delivered too slowly or a drop at a time.	The coffee is ground too finely.	Turn the grinding adjustment knob one click clockwise towards "7" while the coffee mill is in operation (fig. 11). Continue one click at a time until coffee delivery is satisfactory. The effect is only visible after delivering 2 coffees (see the section: "Adjusting the coffee mill" on page 12).
The coffee does not come out of the spouts, but from around the service door.	The holes in the spouts are clogged.	Clean the spouts with a toothpick (fig. 29).
	The coffee guide inside the service door is blocked.	Thoroughly clean the coffee guide, particularly near the hinges.
The milk contains bubbles or squirts out of the milk spout.	The milk is not cold enough or is not semi-skimmed.	You should ideally use skimmed or semi-skimmed milk at refrigerator temperature (about 5°C). If the result is not as you wished, try changing brand of milk.
	The milk container lid is dirty.	Clean the milk container lid as described in the section "Cleaning the milk container" (page 16).
	The hot water/steam nozzle is dirty	Clean the nozzle as described in the section "Cleaning the hot water/steam nozzle" (page 16).
The milk is not frothed.	The milk container lid is dirty.	Clean the milk container lid as described in the section "Cleaning the milk container" (page 16).
	The hot water/steam nozzle is dirty	Clean the nozzle as described in the section "Cleaning the hot water/steam nozzle" (page 16).
	the frothed milk regulator is in the "CAFFELATTE" position.	Put the milk regulator in the "CAPPUCCINO" position.
The appliance does not come on.	It is not plugged into the mains socket.	Plug into the mains socket.
	The main switch is not in position I.	Place the main switch in the I position (fig. 1).
The milk does not come out of the milk spout.	The milk container lid is dirty.	Clean the milk container lid as described in the section "Cleaning the milk container" (page 16).
"Energy Saving" mode is enabled, but the cup warmer is hot	A number of drinks have been prepared in rapid succession.	